

LOOK-IT™

wireless rear vision system

SMART, SIMPLE, SAFE.

LIGHTWAVE TECHNOLOGY INC. is a technology-driven company that designs, engineers and manufactures in and out of car experiences that keep drivers connected and secure. LIGHTWAVE TECHNOLOGY INC. puts design and building innovation at the core of everything they do.

lookitcam.com

© 2017 LOOK-IT. All rights reserved. Made in China.



Installation Guide • Model LI-850

Congratulations on purchasing your LOOK-IT™ Wireless Rear Vision System designed to assist you in a perfect parking experience. Before installing and enjoying the benefits of LOOK-IT™, please read the instructions carefully. For video tutorials on how to install your LOOK-IT™ Wireless Rear Vision System, visit: www.lookitcam.com/support

WHAT IS INCLUDED IN THE PACKAGE?

- License plate holder with built-in wireless camera.
- QuickView wireless remote with dashboard and steering wheel mount.
- Hardware kit including license plate holder brackets and screws.
- Magnetic universal smartphone holder.



WARNING:

Not all objects in your path will be displayed. The performance of the video may vary due to several factors including vehicle, smartphone and environmental conditions.

DOWNLOADING THE APP & PAIRING YOUR SMARTPHONE WITH THE LOOK-IT LICENSE PLATE HOLDER



Go to the App Store or on Google Play to download the “lookit” app by Lightwave Technology and follow the instructions to pair your smartphone. The download links can also be found on www.lookitcam.com/en/support

Note: You need to pair your smartphone before installing your LOOK-IT license plate holder. The pairing code is “1234”.

ACTIVATION BUTTON

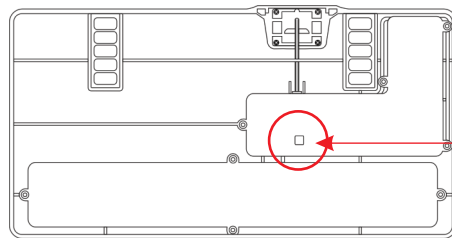

The translucent activation button is used to wake up the system for the first time after it has been purchased or when the internal batteries are replaced. The button includes a visual status indicator that informs about the state of the system. Refer to the instructions in the help section of the application on your smartphone.

PREPARING THE INSTALLATION OF YOUR LOOK-IT™ LICENSE PLATE HOLDER

Remove your licence plate from the vehicle. Do not discard the original screws, as they will be needed for the installation of your LOOK-IT™ license plate holder.

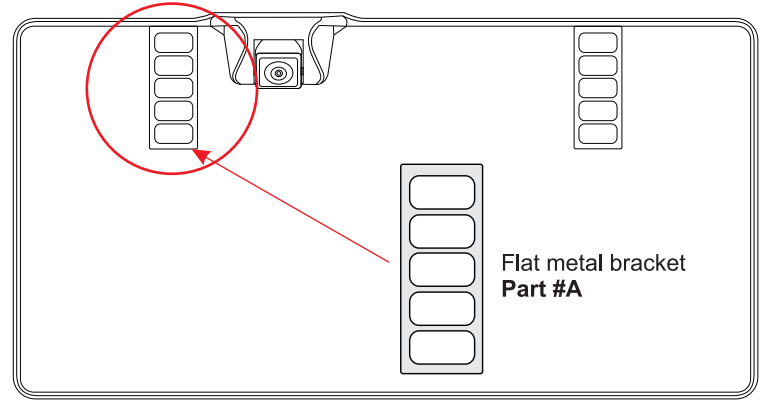
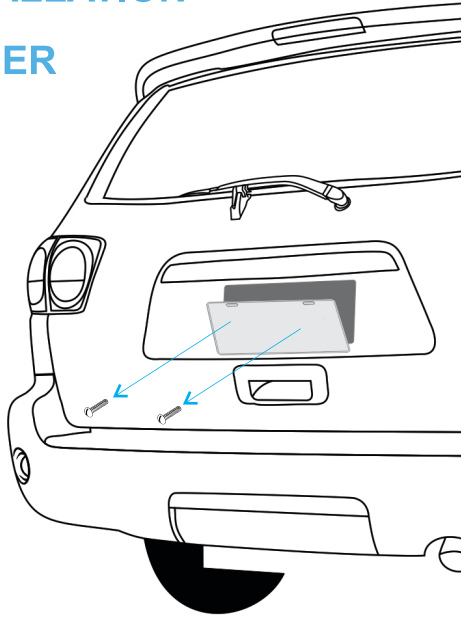

- Place the LOOK-IT™ license plate holder on a flat surface.
- **Unless already factory installed**, insert the flat metal bracket (part #A) in the cavity. Repeat the same steps on the right side.

INSTALLATION OF THE LOOK-IT™ LICENSE PLATE HOLDER ON YOUR VEHICLE

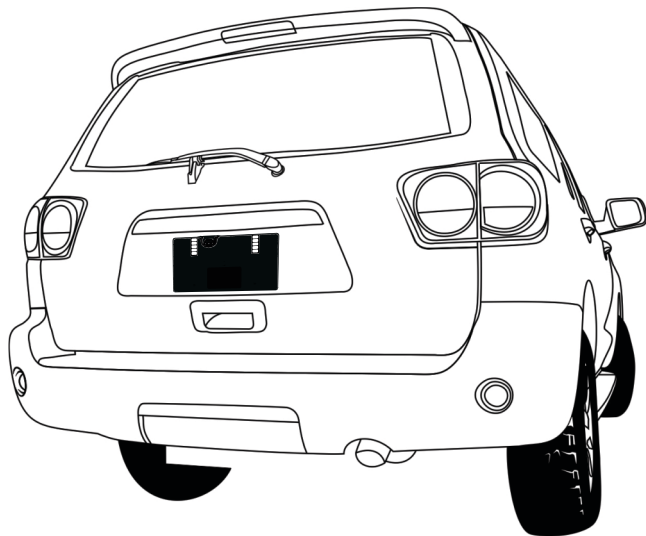

ADJUSTING THE HEIGHT OF THE LOOK-IT™ LICENSE PLATE HOLDER

Hole #2 is the **standard position** for most installations.

In some cases, the LOOK-IT™ license plate holder may need to be installed higher or lower than the original license plate position, for reasons such as:

- **An interference due to the rear gate latch location.**
- **The camera height needs to be adjusted for a better viewing position.**
- **The license plate holder is interfering with the vehicle trim panels or bumper.**

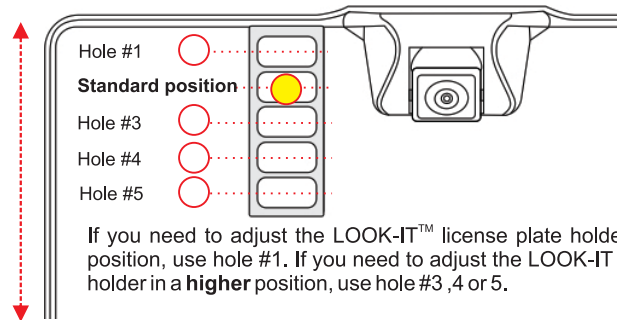

INSTALLATION OF YOUR LOOK-IT™ LICENSE PLATE HOLDER ON YOUR VEHICLE

- Place your LOOK-IT™ license plate holder in the correct height location on your vehicle.
- Align the holes with the license plate fastener holes.
- Insert the original screws through the holes, and secure the assembly by turning the screws clockwise until they are tight and secure.

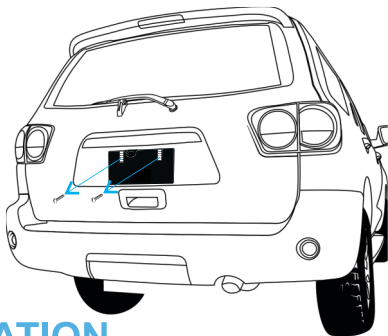

PREPARING THE INSTALLATION OF YOUR LICENSE PLATE

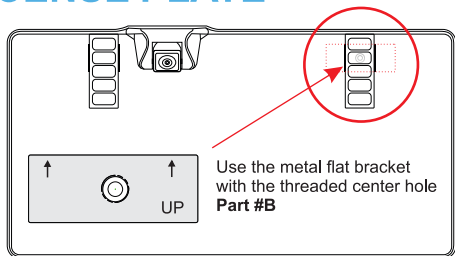

Page 6

lookitcam.com

© 2017 LOOK-IT. All rights reserved. Made in China.

Step #1:

Slide the flat bracket with the threaded hole (part #B) in the right side cavity of the license plate holder.

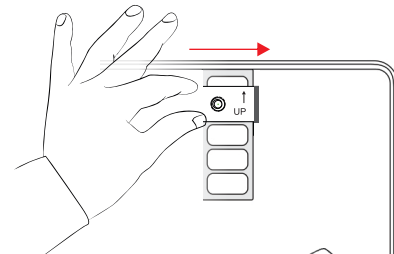

Step #2:

Slide the flat bracket to the left side cavity of the license plate holder, and make sure the center threaded hole is in the middle.

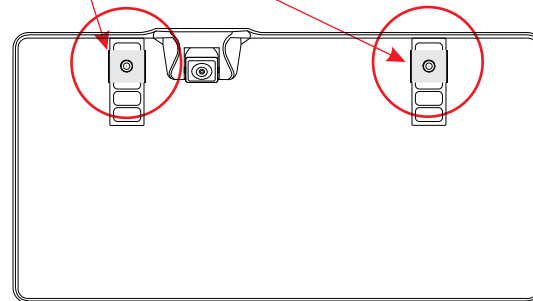
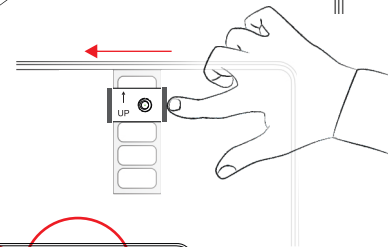

Page 7

For video tutorials, visit www.lookitcam.com/en/support

INSTALLATION OF YOUR LICENSE PLATE ON THE LOOK-IT™ LICENSE HOLDER

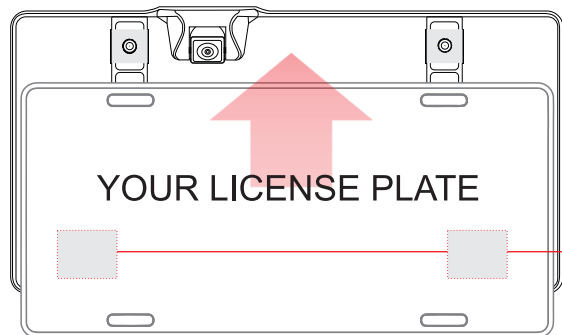

Step #2: Insert your license plate by sliding it **underneath** the camera, while making sure the holes are aligned.

Step #1: To secure your license plate bottom, install adhesive tape (part #F) behind your license plate, and your LOOK-IT™ license plate holder near the bottom.

Re-install your license plate with the two short silver Torx screws (part #C) and the protective rubber cap (part #D).

Before screwing your license plate into the LOOK-IT™ license plate holder, place the protective plastic caps (part #D) and washers (part #E) together and assemble as shown in the diagram below. Use the Torx driver (part #H) to turn the screws clock-wise until they are tight and secure. Once that is done, close and snap the plastic caps.

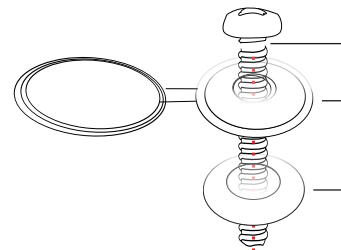
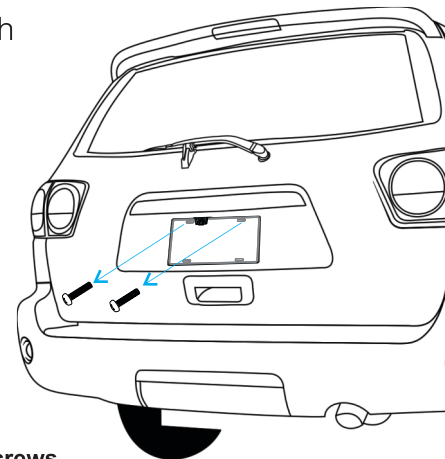

Torx screws
(Part #C)

Plastic cap
(Part #D)

Metal washers (Must be installed
for correct assembly)
(Part #E)

ADJUSTING THE CAMERA ANGLE

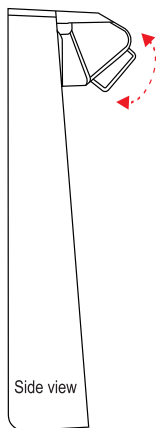
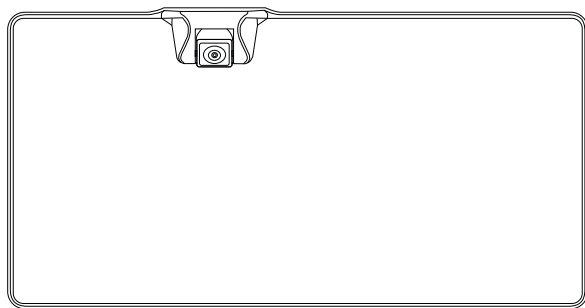

Depending on the height of the LOOK-IT™ Camera License plate assembly, the camera portion can be adjusted up or down, in order to get the best view possible. Use mild force if necessary when adjusting the camera.



QUICKVIEW REMOTE CONTROL

A 3-button wireless remote control is included with your LOOK-IT™ Wireless Rear Vision System. The QuickView wireless remote is used to launch the rear vision camera when needed.

To turn the rear view camera ON:

- **Before putting your vehicle in reverse**, press the  button. Within seconds, the LOOK-IT™ app will automatically launch your smartphone screen, and display a live view of what is behind your vehicle.

To turn the rear view camera OFF:

- You can turn off the rear view camera by simply pressing the  button of the QuickView wireless remote, or the live view will turn off automatically within 30 seconds.

F1 and F2 buttons:

- Visit our web site for future updates on the F1 and F2 button functions.

MOUNTING THE REMOTE CONTROL

The QuickView remote control can be mounted on your steering wheel or dashboard. For the steering application, use the hook and loop fastener strap cradle. For the dashboard application, use the double-sided adhesive tape. The Velcro® strap is designed to install the QuickView remote control securely on a steering wheel, shifter gear or handbrake.

Depending on its location, the QuickView remote control may need to be turned 180° upside-down or the other way around in the cradle. Simply remove the remote from the cradle, and snap it back in its right location.

REMOTE MOUNTING LOCATION EXAMPLES

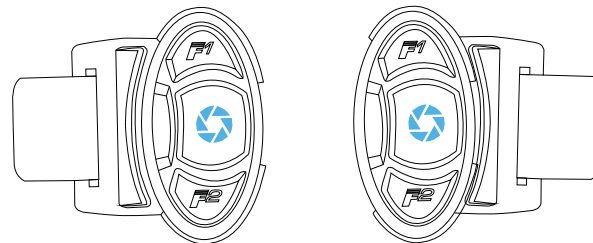
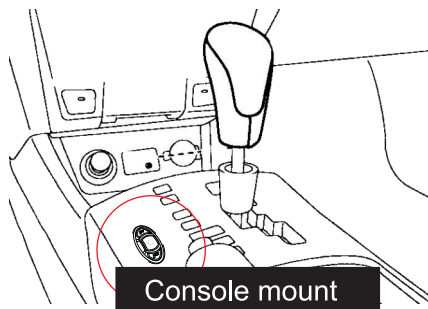
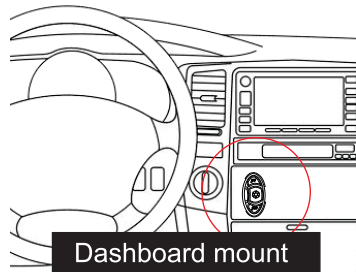
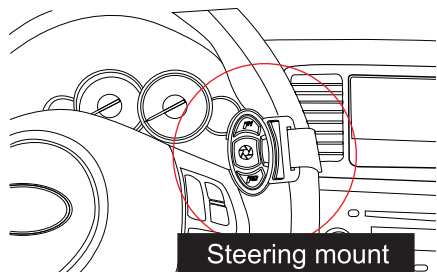

Rotate the remote in the cradle for left or right installation on the steering wheel

⚠ ATTENTION WHEN USING THE ADHESIVE TAPE:

- The adhesive tape (part #G) can permanently secure the remote control to the console, centre console, dashboard or any other places where it can be easily accessible to activate.
- ✓ Choose a location that offers a flat surface large enough to accommodate the back of the remote control.
- ✓ A smooth solid surface will offer better adherence than a grainy surface such as a vinyl dash pad or leather imprint material.
- ✓ Any traces of oil, dirt, vinyl or leather protector (such as ArmorAll® and/or any other interior wax, flat or glossy protecting agent) will prevent the tape from adhering securely to the surface.
- ✓ It is very important to thoroughly clean the mounting surface and the back of the remote before securing it.
- ✓ Use the alcohol cleaning pad (part #K) and rub gently to prepare the surface.
- ✓ Wipe dry before applying the adhesive tape.
- ✓ NEVER use hard solvent like acetone or nail polish remover, as this can discolor or damage the surface permanently.
- ✓ Do not attempt to install on a fabric covered surface, as the adhesive will not work well.
- ✓ NEVER install the remote control in front of an airbag, such as the centre of the steering wheel.

TO REMOVE THE QUICKVIEW REMOTE FROM THE CRADLE REFER TO THE DIAGRAM:

- Use a flat screwdriver and gently pry up the top tab, while pulling back the remote until it is released
- Repeat the same operation on the lower tab
- Do not apply too much force, as you might break the holding tabs
- With the remote control now free from the cradle, you can do any of the following:
 - ✓ Use the provided oval double-sided tape to mount it on your preferred location in your vehicle
 - ✓ Re-insert it in the cradle in the correct orientation, depending on your cradle mounting location
 - ✓ Replace the battery

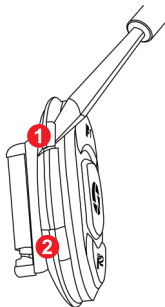

REPLACING THE QUICKVIEW REMOTE BATTERY:

Under normal usage, the lifespan of your QuickView remote battery will be up to 4 years. Please refer to the LOOKITCAM app on your smartphone to monitor the condition of the battery. The remote control uses one CR2016 coin cell battery.

To open the remote control casing:

- Locate the 2 slots on either side of the remote control casing
- Using a flat screwdriver small enough to fit, insert its blade into one of the slots (as illustrated in the diagram)
- Rotate the screwdriver blade counterclockwise. This will partially separate the casing
- Repeat the same operation in the other slot on the same side. This will completely separate the casing
- Take note of the orientation of the circuit board
- Take the electronic board out of the top portion of the casing
- Slide the battery out from the holder to replace it
- Insert the new coin cell battery with the "+" facing up.
(The positive side of the battery features a "+" sign, as well as the battery type.)

- Reassemble the remote
- **The electronic board can ONLY be inserted in ONE position inside the case**
- Hold the top portion of the case that includes the rubber buttons
- Insert the electronic board with the battery holder facing **down**, in the same orientation as the F2 button
- The battery holder will be facing out
- Apply light pressure on the back cover to snap it back into place

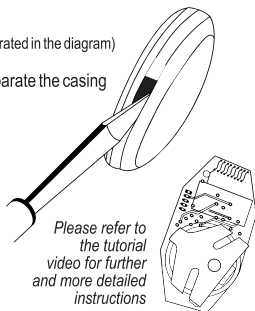

MAGNETIC SMARTPHONE HOLDER INSTALLATION

- Fasten the magnetic mount to the vehicle air vent using the holding clip.
- If your smartphone is equipped with a case cover, place the metal plate between your smartphone and its case cover.
- Clean the back of your smartphone and/or case cover.
- Stick the adhesive metal pad to the back of your smartphone and/or case cover.
- Place your smartphone near the magnetic mount to attach it.
- The back side of your smartphone (with the adhesive metal pad) must be facing the magnetic mount.

Option A

(Smartphone without a case)

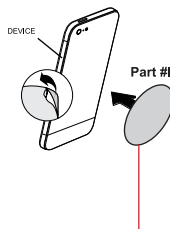

Option B

(Smartphone with a case)

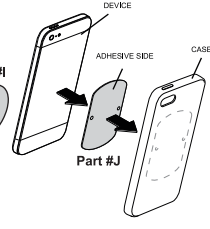

Option C

(Recommended for larger smartphone with a case)

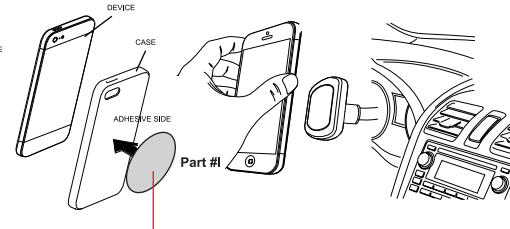

WARNING:

Round adhesive plate is **permanent and cannot be removed.**

HARDWARE DESCRIPTION



Flat metal X 2
Part #A



Metal bracket with
center threaded hole X 2
Part #B



License plate Torx screws X 2
Part #C



Protective rubber cap and washer X 2
Part #D



Metal washer X 2
Part #E



License adhesive tape X 2
Part #F



QuickView adhesive tape X 1
Part #G



Torx driver X 1
Part #H

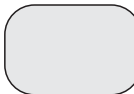

Smartphone adhesive plate
type 1 X 1
Part #I

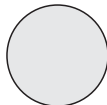

Smartphone adhesive plate
type 2 X 1
Part #J

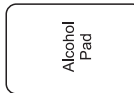

Alcohol cleaning pad X 1
Part #K

WARRANTY

LIGHTWAVE TECHNOLOGY INC. warrants that the LOOK-IT™ Wireless Rear Vision System will be free of any defect in materials or workmanship for the period of (1) year. The warranty begins from the date of purchase. The above warranties cover only defects arising under normal use, and do not include malfunctions or failures resulting from misuse, abuse, neglect, alteration, problems with electrical power, usage not in accordance with product instructions, acts of nature or improper installation. LIGHTWAVE TECHNOLOGY INC. reserves the right to substitute functionally-equivalent new or serviceable used parts.

Questions or problems?

For Canada, please contact LIGHTWAVE TECHNOLOGY INC. at 1-888-644-8882 and for USA call VOXX Corporation at 800-645-4994.

* iPhone and the Made for iPhone logo are trademarks of Apple Inc., registered in the U.S. and other countries. App Store is a service mark of Apple Inc. registered in the U.S. and other countries.

Compatible with iPhone 6 and iPhone 5s.

Google Play and the Google Play logo are trademarks of Google Inc.